

XCubeNXT 8100

Hardware Manual

September 2023

ANNOUNCEMENT

Copyright

© Copyright 2023 QSAN Technology, Inc. All rights reserved. No part of this document may be reproduced or transmitted without written permission from QSAN Technology, Inc.

QSAN believes the information in this publication is accurate as of its publication date. The information is subject to change without notice.

Trademarks

- QSAN, the QSAN logo, QSAN.com, XCubeFAS, XCubeSAN, XCubeNXT, XCubeNAS, XCubeDAS, XEVO, SANOS, and QSM are trademarks or registered trademarks of QSAN Technology, Inc.
- Microsoft, Windows, Windows Server, and Hyper-V are trademarks or registered trademarks of Microsoft Corporation in the United States and/or other countries.
- Linux is a trademark of Linus Torvalds in the United States and/or other countries.
- UNIX is a registered trademark of The Open Group in the United States and other countries.
- Mac and OS X are trademarks of Apple Inc., registered in the U.S. and other countries.
- Java and all Java-based trademarks and logos are trademarks or registered trademarks of Oracle and/or its affiliates.
- VMware, ESXi, and vSphere are registered trademarks or trademarks of VMware, Inc. in the United States and/or other countries.
- Citrix and Xen are registered trademarks or trademarks of Citrix Systems, Inc. in the United States and/or other countries.
- Other trademarks and trade names used in this document to refer to either the entities claiming the marks and names or their products are the property of their respective owners.

TABLE OF CONTENTS

Announcement	i
Notices	vi
Regulatory Statements	vii
FCC Statement	vii
CE Statement	vii
UL Statement	vii
Preface	xii
About This Manual.....	xii
Related Documents	xii
Technical Support	xiii
Information, Tip, and Caution	xiii
Conventions	xiv
1. Product Overview	1
1.1. Introduction to XCubeNXT Series	1
1.2. Hardware Specifications	3
1.3. Package Contents	3
2. Overview of System Components	4
2.1. Front Panel.....	4
2.2. Rear Panel	8
2.3. Power Supply Units.....	13
2.4. Fan Modules	16
2.5. Cache-to-Flash Memory Protection	17
2.6. Host Cards (Option)	21
3. Install System Hardware	29
3.1. Basic System Installation	29
3.2. Connecting a UPS (Option)	29

3.3.	Connecting the USB LCM (Option)	29
3.4.	Wake-on-LAN / Wake-on-SAS (Option).....	30
3.5.	Installing Memory Modules (Option)	30
4.	Support and Other Resources	33
4.1.	Getting Technical Support	33
4.2.	Documentation Feedback.....	34
Appendix	35
	End-User License Agreement (EULA).....	35

FIGURES

Figure 1-1	XCubeNXT Series Form Factors	2
Figure 2-1	System Controls and Indicators.....	4
Figure 2-2	Disk Drive Numbering.....	7
Figure 2-3	Disk Drive Indicators.....	7
Figure 2-4	Rear Panel Layout.....	9
Figure 2-5	Controller Module Components.....	10
Figure 2-6	Controller LEDs	12
Figure 2-7	Location of the Power Supply Units	14
Figure 2-8	Power Supply Unit Components.....	15
Figure 2-9	Location of the Fan Modules	16
Figure 2-10	Fan Module Components.....	17
Figure 2-11	Location of the Cache-to-Flash Modules.....	18
Figure 2-12	Cache-to-flash Module Pack.....	19
Figure 2-13	Cache-to-Flash Module Components.....	19
Figure 2-14	Cache-to-Flash Workflow	20
Figure 2-15	Flash Module LEDs and Button.....	20
Figure 2-16	2-port 32 Gb Fibre Channel Host Card (SFP28) LEDs	23
Figure 2-17	4-port 16 Gb Fibre Channel Host Card (SFP+) LEDs.....	24
Figure 2-18	2-port 16 Gb Fibre Channel Host Card (SFP+) LEDs.....	25
Figure 2-19	2-port 25 GbE iSCSI Host Card (SFP28) LEDs	26
Figure 2-20	4-port 10 GbE iSCSI Host Card (SFP+) LEDs	27
Figure 2-21	2-port 10 GBASE-T iSCSI Host Card (RJ45) LEDs.....	28
Figure 3-1	Memory Module Slot Number	31

TABLES

Table 1-1	XCubeNXT Series Models.....	2
Table 2-1	Descriptions of the System Controls and Indicators.....	5
Table 2-2	Descriptions of the Disk Drive Indicators.....	8
Table 2-3	Descriptions of the Rear Panel Layout.....	9
Table 2-4	Descriptions of the Controller Module Components	10
Table 2-5	Descriptions of the Controller LEDs.....	12
Table 2-6	Descriptions of the Location of the Power Supply Units.....	14
Table 2-7	Descriptions of the Power Supply Unit Components	15
Table 2-8	Descriptions of the Power Supply Unit LED.....	15
Table 2-9	Descriptions of the Location of the Fan Modules.....	16
Table 2-10	Descriptions of the Fan Module Components.....	17
Table 2-11	Descriptions of the Location of the Cache-to-Flash Modules	18
Table 2-12	Descriptions of the Cache-to-Flash Module Components	19
Table 2-13	Descriptions of the Flash Module LEDs and Button	21
Table 2-14	Descriptions of the 2-port 32 Gb Fibre Channel Host Card (SFP28) LEDs.....	23
Table 2-15	Descriptions of the 4-port 16 Gb Fibre Channel Host Card (SFP+) LEDs.....	24
Table 2-16	Descriptions of the 2-port 16 Gb Fibre Channel Host Card (SFP+) LEDs.....	25
Table 2-17	Descriptions of the 2-port 25 GbE iSCSI Host Card (SFP28) LEDs.....	26
Table 2-18	Descriptions of the 4-port 10 GbE iSCSI Host Card (SFP+) LEDs.....	27
Table 2-19	Descriptions of the 2-port 10 GBASE-T iSCSI Host Card (RJ45) LEDs.....	28
Table 3-1	Optional Memory Module Installation Sequence	31

NOTICES

Information contained in this document has been reviewed for accuracy. But it could include typographical errors or technical inaccuracies. Changes are made to the document periodically. These changes will be incorporated in new editions of the publication. QSAN may make improvements or changes in the products. All features, functionality, and product specifications are subject to change without prior notice or obligation. All statements, information, and recommendations in this document do not constitute a warranty of any kind, express or implied.

Any performance data contained herein was determined in a controlled environment. Therefore, the results obtained in other operating environments may vary significantly. Some measurements may have been made on development-level systems and there is no guarantee that these measurements will be the same on generally available systems. Furthermore, some measurements may have been estimated through extrapolation. Actual results may vary. Users of this document should verify the applicable data for their specific environment.

This information contains examples of data and reports used in daily business operations. To illustrate them as completely as possible, the examples include the names of individuals, companies, brands, and products. All of these names are fictitious and any similarity to the names and addresses used by an actual business enterprise is entirely coincidental.

REGULATORY STATEMENTS

FCC Statement

This device has been shown to be in compliance with and was tested in accordance with the measurement procedures specified in the Standards and Specifications listed below.

Technical Standard: FCC Part 15 Class A
 IC ICES-003

This device complies with Part 15 of the FCC rules. Operation is subject to the following two conditions: (1) this device may not cause harmful interference, and (2) this device must accept any interference received, including interference that may cause undesired operation.

この装置は、クラス A 情報技術装置です。この装置を家庭環境で使用すると電波妨害を引き起こすことがあります。この場合には使用者が適切な対策を講ずるよう要求されることがあります。VCC1-A

警告：這是甲類的資訊產品。在居住的環境中使用時，可能會造成射頻干擾，在這種情況下，使用者會被要求採取某些適當的對策。

CE Statement

This device has been shown to be in compliance with and was tested in accordance with the measurement procedures specified in the Standards and Specifications listed below.

Technical Standard: EMC DIRECTIVE 2014/30/EU
 (EN55032 / EN55035)

UL Statement

Rack Mount Instructions - The following or similar rack-mount instructions are included with the installation instructions:

1. Elevated Operating Ambient - If installed in a closed or multi-unit rack assembly, the operating ambient temperature of the rack environment may be greater than room ambient. Therefore, consideration should be given to installing the equipment in an environment compatible with the maximum ambient temperature (T_{ma}) specified by the manufacturer.
2. Reduced Air Flow - Installation of the equipment in a rack should be such that the amount of air flow required for safe operation of the equipment is not compromised.
3. Mechanical Loading - Mounting of the equipment in the rack should be such that a hazardous condition is not achieved due to uneven mechanical loading.
4. Circuit Overloading - Careful consideration should be given to the connection of the equipment to the supply circuit and the effect that overloading of the circuits might have on overcurrent protection and supply wiring. Appropriate consideration of equipment nameplate ratings should be used when addressing this concern.
5. Reliable Earthing - Reliable earthing of rack-mounted equipment should be maintained. Particular attention should be given to supply connections other than direct connections to the branch circuit (e.g. use of power strips).



CAUTION

The main purpose of the system left and right ears are for 19" rack use only. Do NOT use those ears to carry or transport the system.

The ITE is not intended to be installed and used in a home, school or public area accessible to the general population, and the thumbscrews should be tightened with a tool after both initial installation and subsequent access to the panel.

Warning: Always remove all power supply cords before service

This equipment intended for installation in restricted access locations.

- Access should only be allowed by qualified SERVICE PERSONS or by USERS who have been instructed about the reasons for the restrictions applied to the location and about any precautions that shall be taken.
- Access is through the use of a TOOL or lock and key, or other means of security, and is controlled by the authority responsible for the location.
- Recommended operation temperature: 0°C ~ 35°C (32°F ~ 95°F); operation rating (100-127 Vac, 50-60Hz, 10.0A; 200-240 Vac, 50-60Hz, 5.0A)



CAUTION

CAUTION: (English)

Risk of explosion if battery is replaced by incorrect type. Please replace the same or equivalent type battery use and dispose of used batteries according to the instructions.

ATTENTION: (French)

IL Y A RISQUE D'EXPLOSION SI LA BATTERIE EST REMPLACÉE PAR UNE BATTERIE DE TYPE INCORRECT. METTRE AU REBUT LES BATTERIES USAGÉES CONFORMEMENT AUX INSTRUCTIONS.

VORSICHT: (German)

Explosionsgefahr bei unsachgemäßem Austausch der Batterie. Entsorgung gebrauchter Batterien nach Anleitung.

ADVERTENCIA: (Spanish)

Las baterías pueden explotar si no se manipulan de forma apropiada. No desmonte ni tire las baterías al fuego. Siga las normativas locales al desechar las baterías agotadas.

ВНИМАНИЕ: (Russian)

Опасность взрыва при замене батареи неправильного типа. Пожалуйста, устанавливайте на место батареи такого же или аналогичного типа и утилизируйте использованные батареи в соответствии с инструкциями.

警告: (Traditional Chinese)

電池如果更換不正確會有爆炸的危險，請依製造商說明處理用過之電池。

警告: (Simplified Chinese)

电池如果更换不正确会有爆炸的危险，请依制造商说明处理用过之电池。



CAUTION

Replacing incorrect type of battery will have the risk of explosion. Please replace the same or equivalent type battery use and dispose of used batteries according to the instructions.



CAUTION RESTRICTED ACCESS LOCATION

This system is intended for installation only in restricted access locations as defined where both these conditions apply:

- Access can only be gained by service persons or by users who have been instructed about the reasons for the restrictions applied to the location and about any precautions that shall be taken.
- Access is through the use of a tool or lock and key, or other means of security, and is controlled by the authority responsible for the location.

Warning

- Electric shock hazard

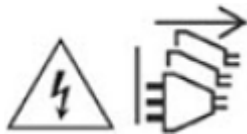

The system may have one or more power supply unit (PSU) cords. To avoid serious injuries, it is recommended that all PSU power cords must be disconnected by trained service technicians before installing or replacing system components.



INFORMATION

QSAN provides limited warranty for QSAN-branded hardware products:

- System hardware and peripheral product (s): 3 years limited warranty from date of original purchase.
- Battery Backup Module or super capacitor module (applies for cache-to-flash module): 1-year limited warranty from date of original purchase.

For more detail warranty policy, please refer to QSAN official web site:

<https://www.qsan.com/warranty>

PREFACE

About This Manual

This manual provides technical guidance for designing and implementing QSAN XCubeNXT series unified storage array system, and it is intended for use by system administrators, NXT designers, storage consultants, or anyone who has purchased these products and is familiar with servers and computer networks, network administration, storage system installation and configuration, storage area network management, and relevant protocols.



CAUTION

Do NOT attempt to service, change, disassemble or upgrade the equipment's components by yourself. Doing so may violate your warranty and expose you to electric shock. Refer all servicing to authorized service personnel. Please always follow the instructions in this owner's manual.

Related Documents

There are related documents which can be downloaded from the website.

- [Quick Installation Guide](#)
- [QSM Software Manual](#)
- [Compatibility Matrix](#)
- [White Papers](#)
- [Application Notes](#)

Technical Support

Do you have any questions or need help trouble-shooting a problem? Please contact QSAN Support, we will reply to you as soon as possible.

- Via the Web: https://www.qsan.com/technical_support
- Via Telephone: +886-2-77206355
- (Service hours: 09:30 - 18:00, Monday - Friday, UTC+8)
- Via Skype Chat, Skype ID: qsan.support
- (Service hours: 09:30 - 02:00, Monday - Friday, UTC+8, Summer time: 09:30 - 01:00)
- Via Email: support@qsan.com

Information, Tip, and Caution

This manual uses the following symbols to draw attention to important safety and operational information.



INFORMATION

INFORMATION provides useful knowledge, definition, or terminology for reference.



TIP

TIP provides helpful suggestions for performing tasks more effectively.



CAUTION

CAUTION indicates that failure to take a specified action could result in damage to the system.

Conventions

The following table describes the typographic conventions used in this manual.

CONVENTIONS	DESCRIPTION
Bold	Indicates text on a window, other than the window title, including menus, menu options, buttons, fields, and labels. Example: Click the OK button.
<i><Italic></i>	Indicates a variable, which is a placeholder for actual text provided by the user or system. Example: copy <i><source-file></i> <i><target-file></i> .
[] square brackets	Indicates optional values. Example: [a b] indicates that you can choose a, b, or nothing.
{ } braces	Indicates required or expected values. Example: { a b } indicates that you must choose either a or b.
vertical bar	Indicates that you have a choice between two or more options or arguments.
/ Slash	Indicates all options or arguments.
underline	Indicates the default value. Example: [<u>a</u> b]

1. PRODUCT OVERVIEW

Thank you for purchasing QSAN Technology, Inc. products. XCubeNXT 8100 is the leading entry-level unified storage array developed to allow all enterprises to easily enter the era of unified storage.

1.1. Introduction to XCubeNXT Series

QSAN XCubeNXT series is a unified storage system, the system is composed of system hardware and the QSM operating system, the system hardware is a modular design and FRU (Field Replacement Unit) optimized. All the hardware modules are inside the rack mount chassis including: system controllers, front panel, rear panel, redundant power supply units and fan modules, cache-to-flash modules, and expansion slots for optional Fibre Channel or Ethernet high-speed host cards. This manual will direct you step by step to familiarize you with the hardware components, how to install the system, carry out the initial configuration, and provide you with some quick maintenance guidelines.



INFORMATION

For how to use the QSM operating system, please refer to the [QSM Software Manual](#).

XCubeNXT series supports several standard form factors:

- LFF (Large Form Factor): 24-bay 19" rack mount 4U chassis, 16-bay 19" rack mount 3U chassis, and 12-bay 19" rack mount 2U chassis.
- SFF (Small Form Factor): 26-bay 19" rack mount 2U chassis.

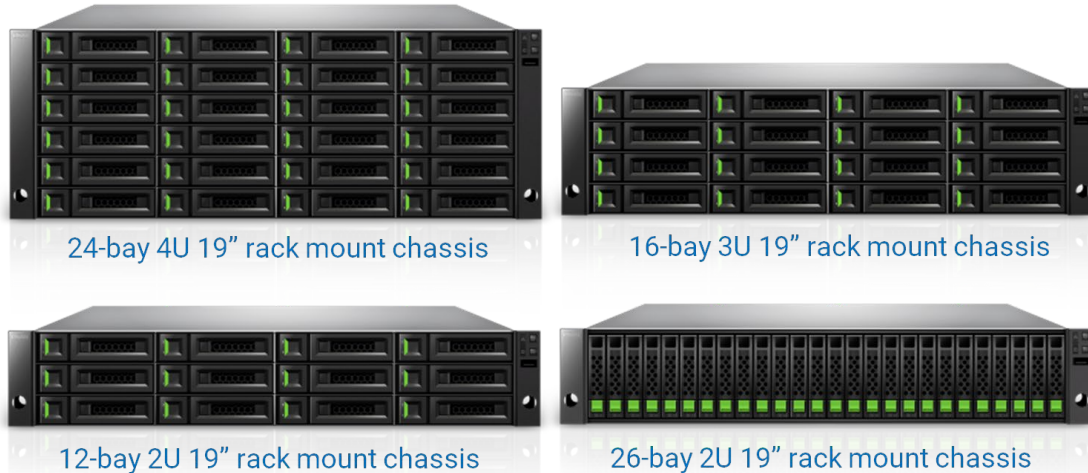

Figure 1-1 XCubeNXT Series Form Factors

The following tables provide detailed information about all XCubeNXT series models arranged by form factors.

Table 1-1 XCubeNXT Series Models

MODEL NAME	CONTROLLER TYPE	FORM FACTOR, BAY COUNT, RACK UNIT
XN8124D	Dual Controller	LFF 24-bay 4U Chassis
XN8124S	Single Controller	LFF 24-bay 4U Chassis
XN8116D	Dual Controller	LFF 16-bay 3U Chassis
XN8116S	Single Controller	LFF 16-bay 3U Chassis
XN8112D	Dual Controller	LFF 12-bay 2U Chassis
XN8112S	Single Controller	LFF 12-bay 2U Chassis
XN8126D	Dual Controller	SFF 26-bay 2U Chassis
XN8126S	Single Controller	SFF 26-bay 2U Chassis

1.2. Hardware Specifications

For detailed hardware specifications, please refer to the [XN8100 Datasheets](#) which can be downloaded from the website.

1.3. Package Contents

For detailed package contents, please refer to the [Quick Installation Guide](#) which can be downloaded from the website.

2. OVERVIEW OF SYSTEM COMPONENTS

This chapter outlines the key hardware components or modules of the system. After reading this chapter, you will have a basic understanding of each part of the hardware and give you the ability to be able to successfully configure and operate your system.

2.1. Front Panel

In this section, we will describe the system controls and indicators, disk drive numbering, and the disk drive LEDs in the front panel.

2.1.1. System Controls and Indicators

The XCubeNEXT series features a unique design: the system controls and indicators are located on the right ear. The system control and indicator module integrate functional buttons and system state indicators, which can be easily operated and read by user. The figure below takes the XN8126 as an example, and contains detailed of the button and indicator module. Please refer to the following for the definition of LED behavior.

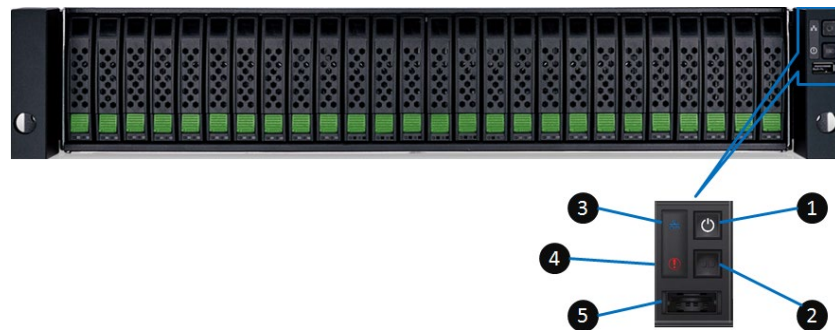

Figure 2-1 System Controls and Indicators

Table 2-1 Descriptions of the System Controls and Indicators

NUMBER	DESCRIPTION	DEFINITION
1	Enclosure Power Button / LED	<p>Power Button</p> <ul style="list-style-type: none"> Press the button one time to turn ON the system power and keep pressing for 4 seconds to turn OFF the system power. <p>Power LED</p> <ul style="list-style-type: none"> Solid White: Power is ON (at least one power supply unit is supplying power to the system). Blinking White: The system is in the stage of boot or shutdown. Off: The system is shutdown.
2	UID Button / LED	<p>UID (Unique Identifier) button</p> <ul style="list-style-type: none"> Press the button one time to turn it ON and press it again to turn it OFF. <p>UID (Unique Identifier) LED</p> <ul style="list-style-type: none"> Solid Blue: The system has been identified. Off: The system has not been identified.
3	Enclosure Access LED	<p>Enclosure Access LED indicates the host interface connectivity.</p> <ul style="list-style-type: none"> Blinking Blue: The host interface activity is on-going. Off: There is no host interface activity.
4	Enclosure Status LED	<p>Enclosure Status LED indicates current health status of the system.</p> <ul style="list-style-type: none"> Solid Amber: System has errors including PSU failure, abnormal voltage, abnormal temperature, any fan module failed or removed, controller degraded, pool

		<p>degraded, pool failure, SSD cache pool degraded, or SSD cache pool failure.</p> <ul style="list-style-type: none"> • Off: The system is healthy.
5	USB Port	The USB port can be plug in the LCM (LCD Module).

2.1.2. System Disk Drive Numbering

Figures below illustrate the XCubeNXT system disk drive numbering. The disk drive numbering for LFF system starts from the top of first row in left column; this kind of disk drive numbering rule helps to balance the system weight distribution and enable easy management of disk drives zoning. The SFF system disk drive numbering is single row from left to right. If you want to check the disk drive numbering rule while installing the disk drives into the system, for LFF, you can find a disk drive numbering sticker on the right side of the system chassis top cover; for SFF system, the disk drive numbering is printed on the lower part of the system front.

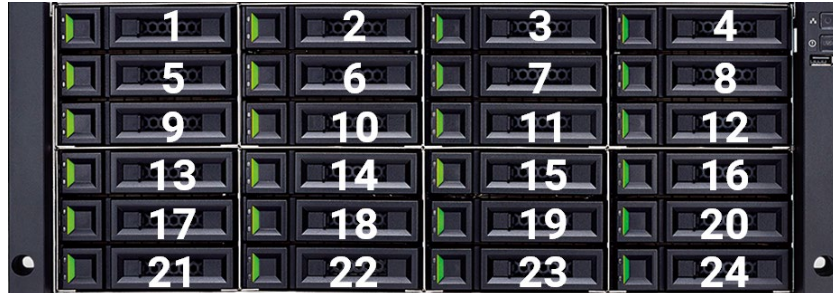



Figure 2-2 Disk Drive Numbering



TIP

Please insert any one of the first four hard drives, the event log can be saved and displayed at the next system startup. Otherwise, the event log cannot be saved.

2.1.3. Disk Drive LEDs

Please refer to the following for the definition of LED behavior.

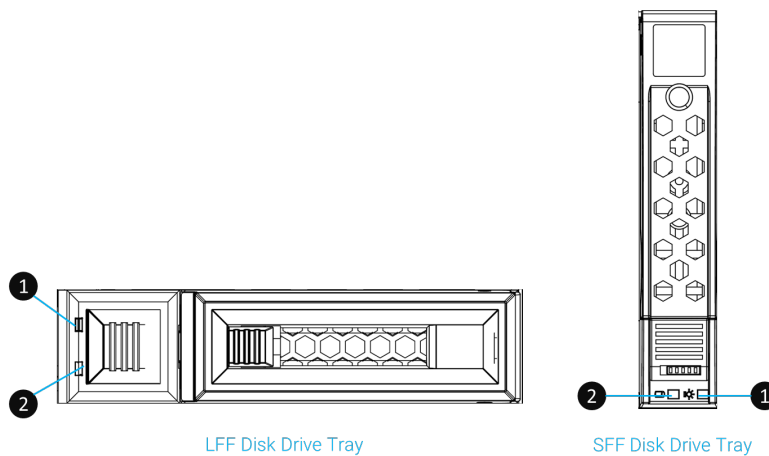

Figure 2-3 Disk Drive Indicators

Table 2-2 Descriptions of the Disk Drive Indicators

NUMBER	DESCRIPTION	DEFINITION
1	Disk Drive Power LED	<ul style="list-style-type: none"> • Solid Blue: The disk drive is inserted and no data access. • Blinking Blue: The disk drive is accessing data. • Off: There is no disk drive inserted.
2	Disk Drive Status LED	<ul style="list-style-type: none"> • Solid Amber: <ul style="list-style-type: none"> ▪ When system is booting. ▪ There is disk drive error. • Blinking Amber (interval of 0.5 sec): The disk drive is rebuilding. • Blinking Amber (interval of 0.05 sec): Identify the disk drive. • Off: The disk drive is healthy.

2.2. Rear Panel

In this section, we will describe the name and location of the key components and modules in the rear panel. The following content outlines the detail of the rear panel and components.

2.2.1. Rear Panel Layout

Figures and the table below illustrate the system rear panel layout.

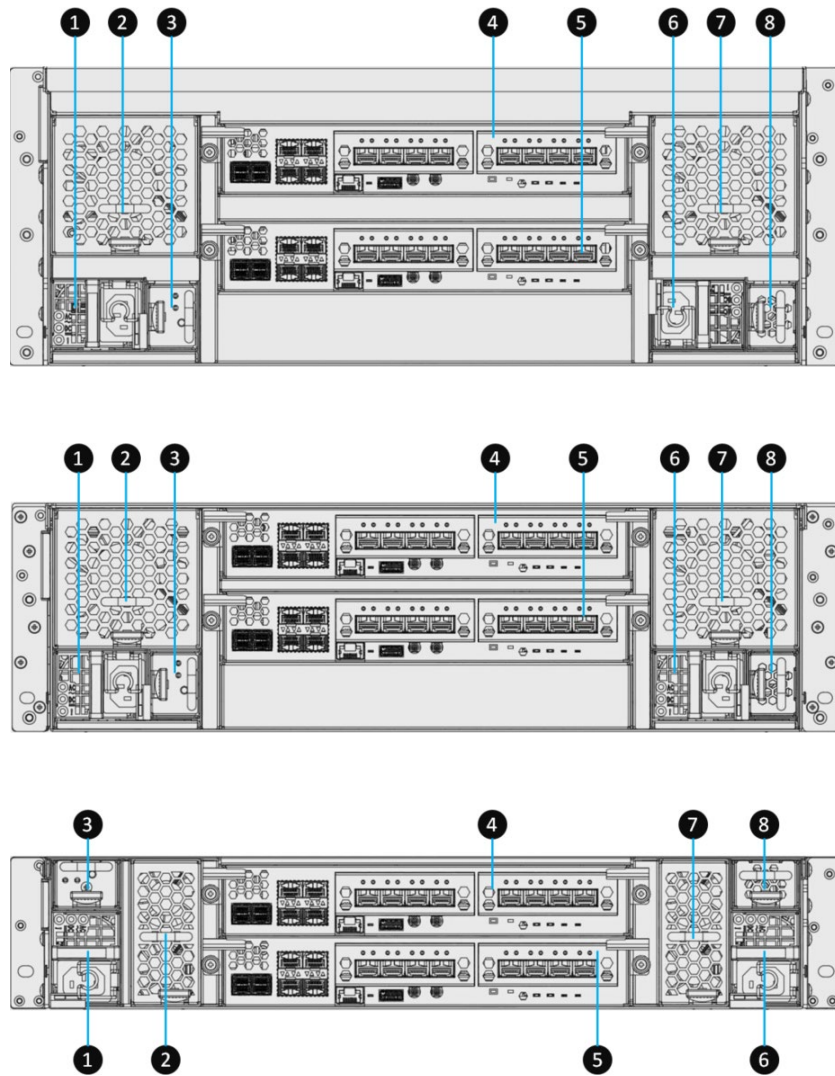

Figure 2-4 Rear Panel Layout

Table 2-3 Descriptions of the Rear Panel Layout

ITEM NUMBER	DESCRIPTION
1	Power Supply Unit 1
2	Fan Module 1
3	Slot for Cache-to-Flash Module: Flash Module
4	Controller Module 1

5	Controller Module 2
6	Power Supply Unit 2
7	Fan Module 2
8	Slot for Cache-to-Flash Module: Power Module

2.2.2. Controller Module

The following image and table illustrate each component of a controller module.

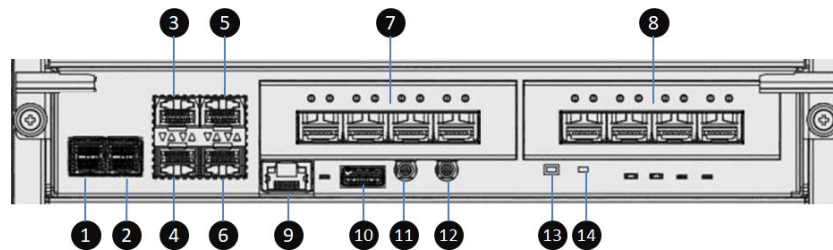

Figure 2-5 Controller Module Components

Table 2-4 Descriptions of the Controller Module Components

ITEM NUMBER	DESCRIPTION
1	12 Gb/s SAS Wide Port 1 (SFF8644)
2	12 Gb/s SAS Wide Port 2 (SFF8644)
3	10 GbE iSCSI (SFP+) Port 1
4	10 GbE iSCSI (SFP+) Port 2
5	10 GbE iSCSI (SFP+) Port 3
6	10 GbE iSCSI (SFP+) Port 4

7	Host Card Slot 1 (host card is an optional part)
8	Host Card Slot 2 (host card is an optional part)
9	Management Port
10	USB Port
11	Console Port (3.5mm jack to RS232) ¹
12	Service Port (UPS) ²
13	Buzzer Mute Button
14	Reset to Factory Default Button ³

¹ Console cable (NULL modem cable) connects from console port of the storage system to a RS 232 port on the management PC. The console settings are on the following: Baud rate: 115,200, 8 data bit, no parity, 1 stop bit, and no flow control; terminal type: vt100.

² System supports traditional UPS via a serial port and network UPS via SNMP. If using the UPS with a serial port, connect the system to the UPS via the included cable for communication. (The cable plugs into the serial cable that comes with the UPS.) Then set up the shutdown values for when the power goes out.

³ Press the button for 3 seconds to progress reset to defaults and force a reboot. The default settings are:

- Reset **Management Port** IP address to DHCP, and then fix IP address: 169.254.1.234/16.
- Reset admin's **Password** to 1234.
- Reset **System Name** to model name plus the last 6 digits of serial number. For example: XS5326-123456.
- Reset IP addresses of all **iSCSI Ports** to 192.168.1.1, 192.168.2.1, ... etc.
- Reset link speed of all **Fibre Channel Ports** to Automatic.
- Clear all access control settings of the host connectivity.

Please refer to the following for the definition of LED behavior.

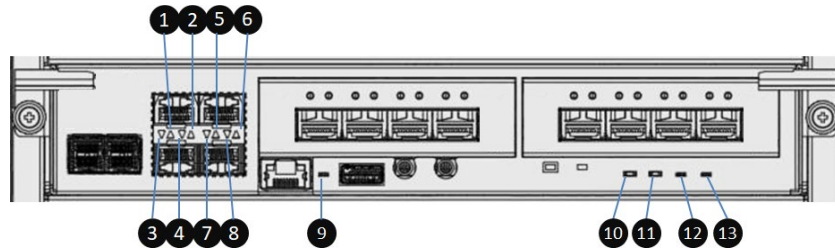

Figure 2-6 Controller LEDs

Table 2-5 Descriptions of the Controller LEDs

NUMBER	DESCRIPTION	DEFINITION
1	10 GbE iSCSI Port 1 Access LED	<ul style="list-style-type: none"> Blinking Green: Link is established and data is being accessed. Off: No data access.
2	10 GbE iSCSI Port 1 Speed LED	<ul style="list-style-type: none"> Solid Blue: 10G link is established and maintained. Solid Amber: 1G / 100M link is established and maintained. Off: No link detected.
3	10 GbE iSCSI Port 2 Access LED	<ul style="list-style-type: none"> Blinking Green: Link is established and data is being accessed. Off: No data access.
4	10 GbE iSCSI Port 2 Speed LED	<ul style="list-style-type: none"> Solid Blue: 10G link is established and maintained. Solid Amber: 1G / 100M link is established and maintained. Off: No link detected.
5	10 GbE iSCSI Port 3 Access LED	<ul style="list-style-type: none"> Blinking Green: Link is established and data is being accessed. Off: No data access.
6	10 GbE iSCSI Port 3 Speed LED	<ul style="list-style-type: none"> Solid Blue: 10G link is established and maintained.

		<ul style="list-style-type: none"> • Solid Amber: 1G / 100M link is established and maintained. • Off: No link detected.
7	10 GbE iSCSI Port 4 Access LED	<ul style="list-style-type: none"> • Blinking Green: Link is established and data is being accessed. • Off: No data access.
8	10 GbE iSCSI Port 4 Speed LED	<ul style="list-style-type: none"> • Solid Blue: 10G link is established and maintained. • Solid Amber: 1G / 100M link is established and maintained. • Off: No link detected.
9	Management Port LED	<ul style="list-style-type: none"> • Blinking Green: Data is being accessed. • Off: No connection is built.
10	Controller Status LED	<ul style="list-style-type: none"> • Solid Green: Controller status is normal. • Solid Red: System is booting, or the controller is failed.
11	Master / Slave LED (only for dual controllers)	<ul style="list-style-type: none"> • Solid Green: This is the Master controller. • Off: This is the Slave controller.
12	Dirty Cache LED	<ul style="list-style-type: none"> • Solid Amber: Data on the cache is waiting for flush to disks. • Off: There is no data on the cache.
13	UID (Unique Identifier) LED	<ul style="list-style-type: none"> • Solid Blue: The enclosure has been identified. • Off: The enclosure is not being identified.

2.3. Power Supply Units

The system is equipped with two redundant and hot swappable PSUs (Power Supply Units). The images and the table below illustrate the location of PSUs in the system.

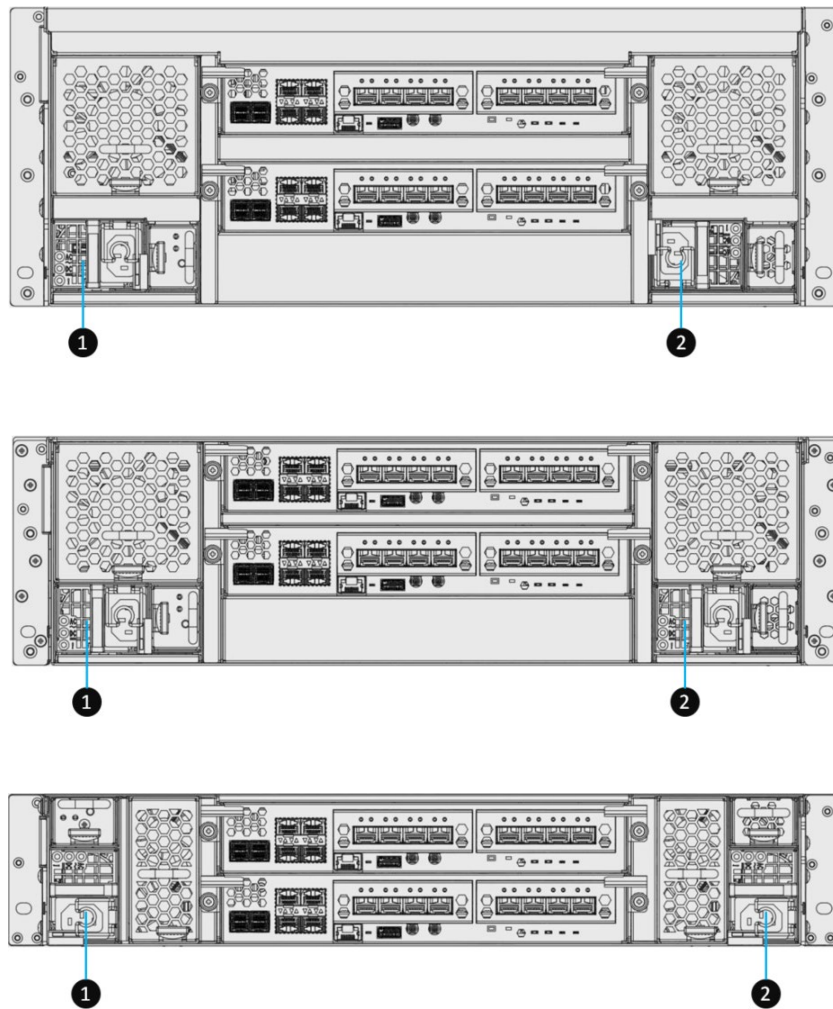

Figure 2-7 Location of the Power Supply Units

Table 2-6 Descriptions of the Location of the Power Supply Units

ITEM NUMBER	DESCRIPTION
1	PSU 1
2	PSU 2

Please refer to the following for the definition of component and LED behavior.

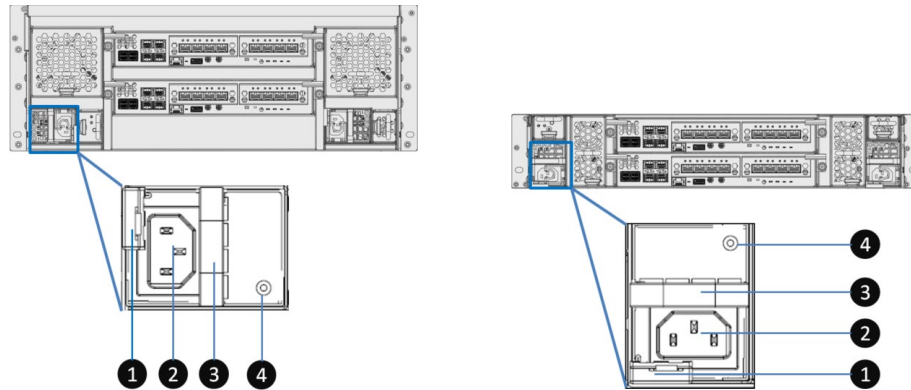

Figure 2-8 Power Supply Unit Components

Table 2-7 Descriptions of the Power Supply Unit Components

ITEM NUMBER	DESCRIPTION
1	PSU Release Tab
2	PSU Power Cord Connect
3	PSU Handle
4	PSU LED Indicator

Table 2-8 Descriptions of the Power Supply Unit LED

NUMBER	DESCRIPTION	DEFINITION
4	PSU LED	<ul style="list-style-type: none"> • Solid Green: The PSU is on and normal. • Blinking Green: The PSU is off, +5VSB (Standby) is on. • Solid Amber: There is critical event caused shutdown. • Blinking Amber: There are PSU warning events including high temperature, high power, high current, slow fan, or under input voltage.

2.4. Fan Modules

The system is equipped with two redundant and hot swappable fan modules. Each fan module includes two fans. Images and tables below illustrate the location and mechanical components of the fan module that is installed in the system.

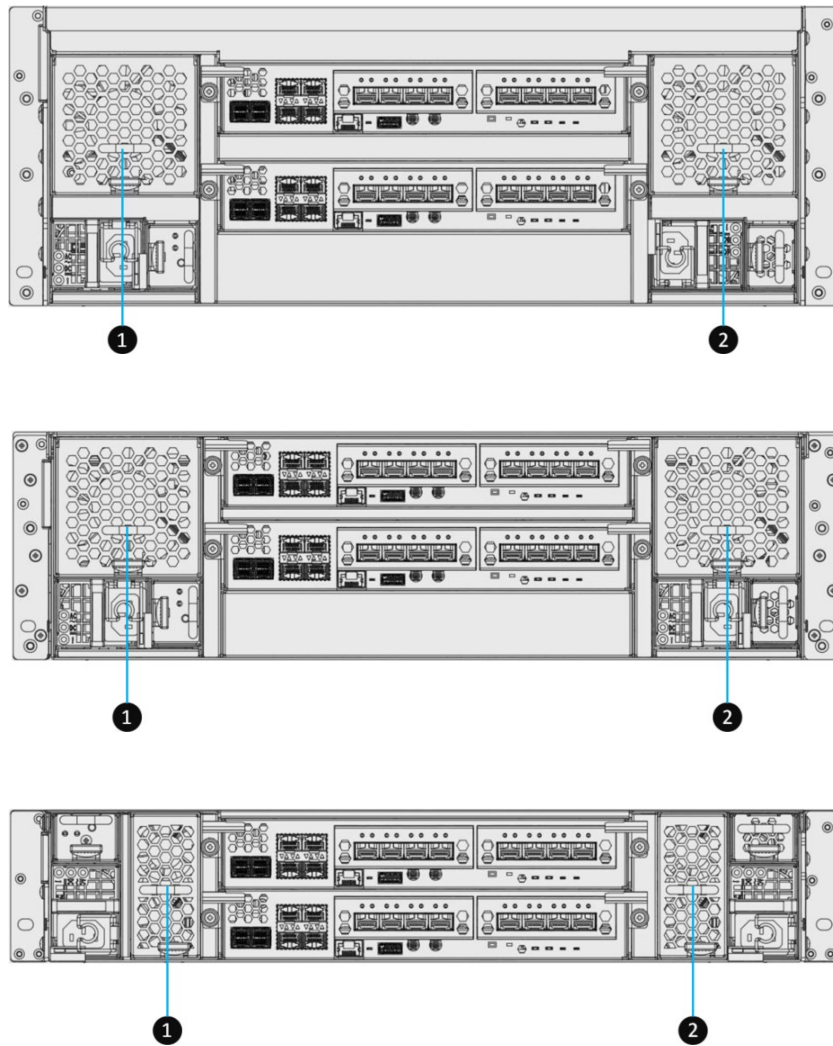

Figure 2-9 Location of the Fan Modules

Table 2-9 Descriptions of the Location of the Fan Modules

ITEM NUMBER	DESCRIPTION
1	Fan 1 and Fan 2

Please refer to the following for the definition of component.

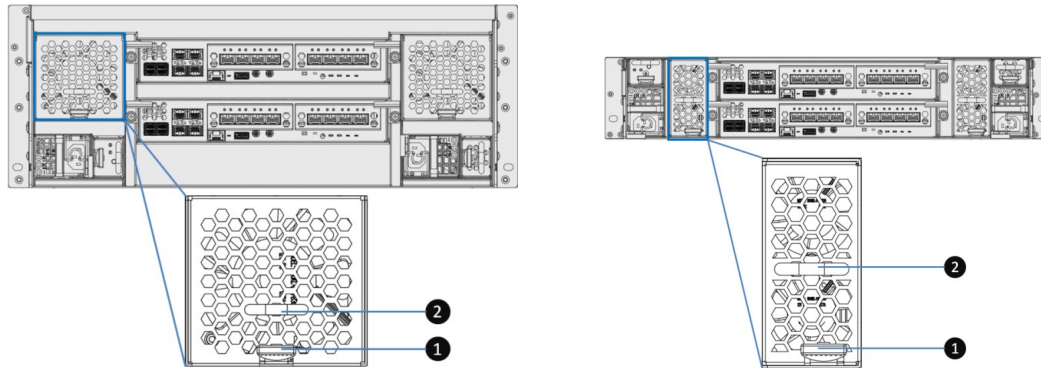

Figure 2-10 Fan Module Components

Table 2-10 Descriptions of the Fan Module Components

ITEM NUMBER	DESCRIPTION
1	Fan Module Release Tab
2	Fan Module Handle

2.5. Cache-to-Flash Memory Protection

In the event of power loss, the I/O cache data stored in the volatile memory will be lost; this can cause data inconsistency especially in database applications. The system can provide an optional Cache-to-Flash memory protection function that will safely transfer the memory cache data to a non-volatile flash device for permanent preservation. The Cache-to-Flash module comes with an M.2 flash module and a supercapacitor module. All modules are hot pluggable with zero system downtime for extra availability and reliability. M.2 flash module can be plugged in on the left-hand side from the rear of the chassis. Power module can be plugged in on the right-hand side from the rear of the chassis. Images and tables below illustrate the location and mechanical components of the cache-to-flash modules.

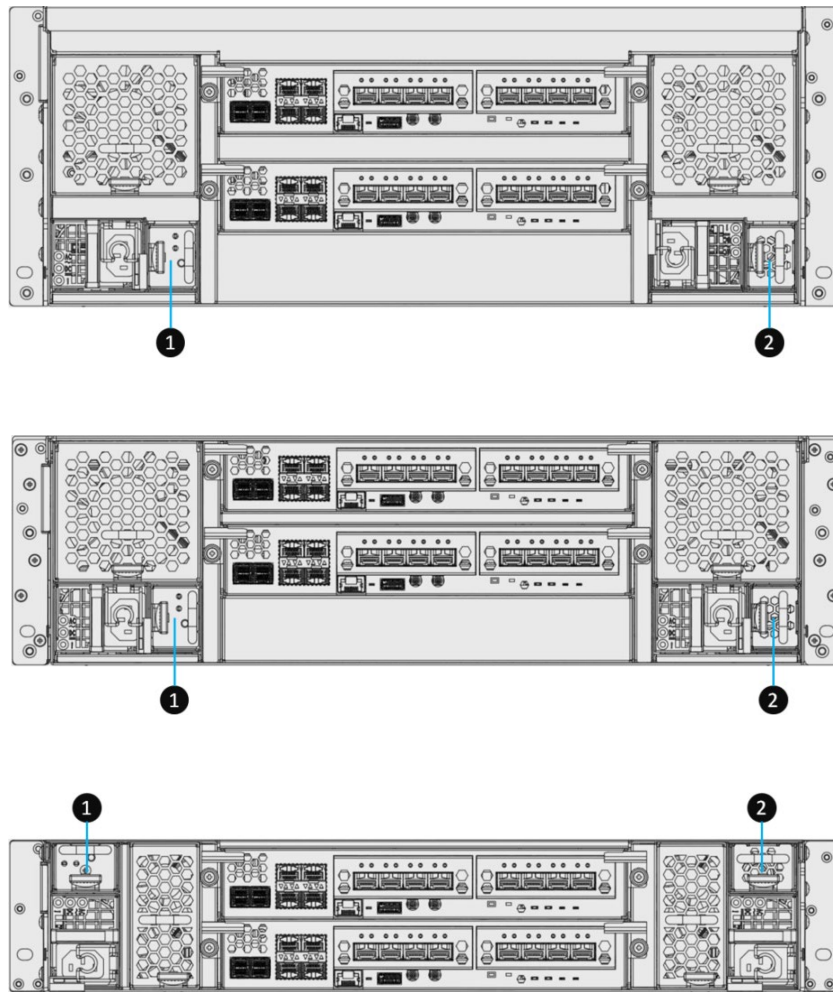

Figure 2-11 Location of the Cache-to-Flash Modules

Table 2-11 Descriptions of the Location of the Cache-to-Flash Modules

ITEM NUMBER	DESCRIPTION
1	Slot for Flash Module
2	Slot for Power Module



Figure 2-12 Cache-to-flash Module Pack

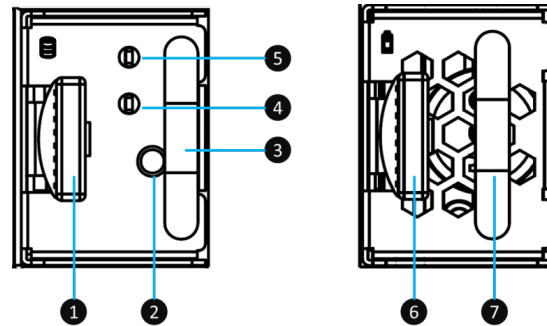

Figure 2-13 Cache-to-Flash Module Components

Table 2-12 Descriptions of the Cache-to-Flash Module Components

ITEM	NUMBER	DESCRIPTION
Flash Module	1	Flash Module Release Tab
	2	Flash Module Attention Button
	3	Flash Module Handle
	4	Flash Module Status LED
	5	Flash Module Power LED
Power Module	6	Power Module Release Tab
	7	Power Module Handle

2.5.1. Mechanism of Cache Data Protection

The following image is the sequence of Cache-to-Flash workflow.

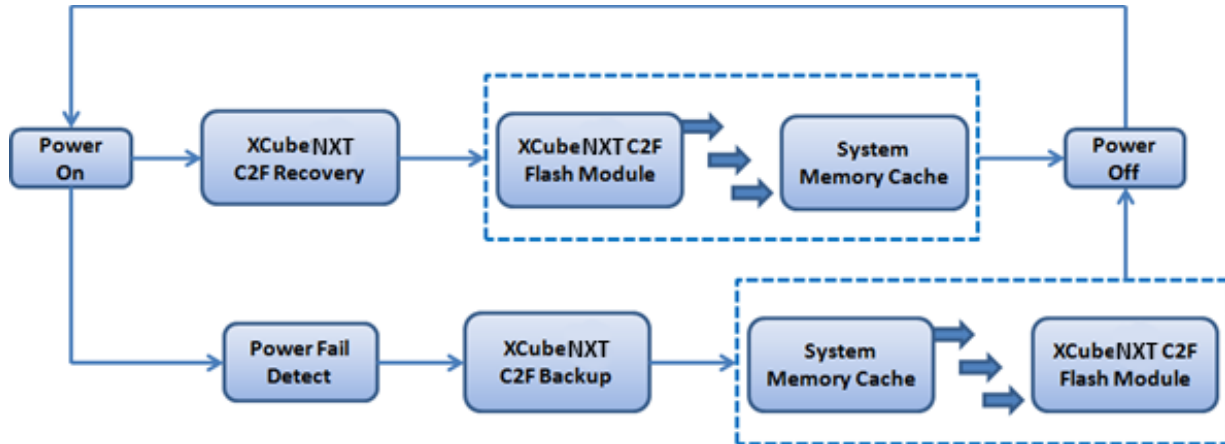

Figure 2-14 Cache-to-Flash Workflow

Cache-to-Flash technology will first flush CPU cache to memory, then flush memory to M.2 flash module to maintain the upmost data consistency. It leverages the strength of both BIOS and CPU to quickly backup memory data to the flash module. In order to quickly move data from memory to flash module, M.2 PCI-Express interface flash module is selected for better performance and less power consumption. In Cache-to-Flash recovery phase, BIOS will check C2F flag status. If C2F flag is ON, I/O cache data will be recovered from the M.2 flash module and then continue normal booting. If C2F flag is OFF, the normal booting process continues.

2.5.2. Cache-to-Flash Module LEDs and Button

Please refer to the following for the definition of LED and button behavior.

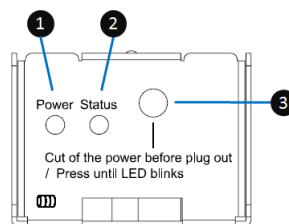

Figure 2-15 Flash Module LEDs and Button

Table 2-13 Descriptions of the Flash Module LEDs and Button

NUMBER	DESCRIPTION	DEFINITION
1	Power LED	<ul style="list-style-type: none"> • Solid Green: Power is good at flash module. • Off: There is no power at flash module.
2	Status LED	<ul style="list-style-type: none"> • Solid Blue: The status of flash module is good. • Blinking Blue and Amber Interlaced: Installing or removing the flash module. • Solid Amber: The flash module is failed or wrong PCIe connection speed.
3	Attention Button	Used to prompt system that the flash module can be removed later.



CAUTION

The flash module of Cache-to-Flash is hot swappable because it is a PCIe device. Before removing the flash module from the system chassis, you must press the **Attention** button until the flash module status LED finished blinking. Otherwise, the flash module maybe damage.

2.6. Host Cards (Option)

The system comes with four on-board 10 GbE iSCSI ports on each controller. If you want to expand the number of host ports, purchase QSAN host cards (optional components) will be the fastest and most cost-efficiency choice.

There are several types of host cards that are available for selection. You can configure a fibre channel by using QSAN 32 Gb or 16 Gb fibre channel host card, or choose an iSCSI host card by using 25 GbE via SFP28 or 10 GbE via SFP+ or RJ45. Following figure is the overview of the host card installation slots.



CAUTION

You must remove the controller module from the system chassis before starting the host card removing or installing procedures.

Host card can NOT hot plug in the controller module. Hot plug in the host card might cause system hang up. You should remove the controller module from the system chassis before removing or installing host card. Please DO NOT attempt to hot plug in the host card.

Please refer to the following for the definition of LED behavior.

2.6.1. 2-port 32 Gb Fibre Channel Host Card (SFP28) LEDs

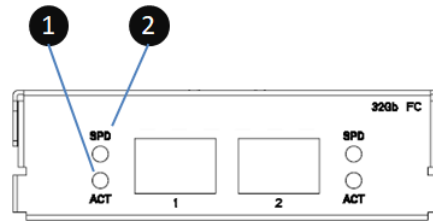

Figure 2-16 2-port 32 Gb Fibre Channel Host Card (SFP28) LEDs

Table 2-14 Descriptions of the 2-port 32 Gb Fibre Channel Host Card (SFP28) LEDs

NUMBER	DESCRIPTION	DEFINITION
1	Activity LED	<ul style="list-style-type: none"> • Solid Green: Asserted when the link is established (Link OK without I/O). • Blinking Green: Asserted when the link is established, and packets are being transmitted along with any receive activity (Access). • Off: No link is detected, or link fails.
2	Speed LED	<ul style="list-style-type: none"> • Solid Blue: Asserted when a 32 Gb link is established and maintained. • Solid Amber: Asserted when a 16 Gb link is established and maintained. • Solid White: Asserted when an 8 Gb and below link is established and maintained. • Off: No link is detected, or link fails.

2.6.2. 4-port 16 Gb Fibre Channel Host Card (SFP+) LEDs

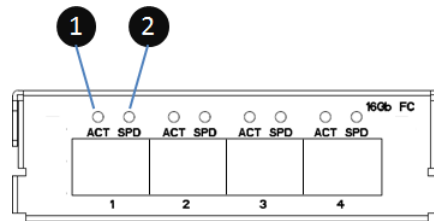

Figure 2-17 4-port 16 Gb Fibre Channel Host Card (SFP+) LEDs

Table 2-15 Descriptions of the 4-port 16 Gb Fibre Channel Host Card (SFP+) LEDs

NUMBER	DESCRIPTION	DEFINITION
1	Activity LED	<ul style="list-style-type: none"> • Solid Green: Asserted when the link is established (Link OK without I/O). • Blinking Green: Asserted when the link is established, and packets are being transmitted along with any receive activity (Access). • Off: No link is detected, or link fails.
2	Speed LED	<ul style="list-style-type: none"> • Solid Blue: Asserted when a 16 Gb link is established and maintained. • Solid Amber: Asserted when an 8 Gb link is established and maintained. • Solid White: Asserted when a 4 Gb and below link is established and maintained. • Off: No link is detected, or link fails.

2.6.3. 2-port 16 Gb Fibre Channel Host Card (SFP+) LEDs

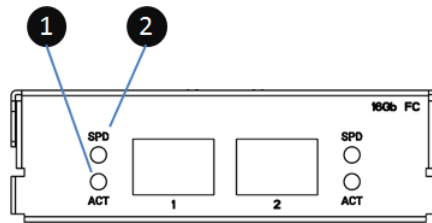

Figure 2-18 2-port 16 Gb Fibre Channel Host Card (SFP+) LEDs

Table 2-16 Descriptions of the 2-port 16 Gb Fibre Channel Host Card (SFP+) LEDs

NUMBER	DESCRIPTION	DEFINITION
1	Activity LED	<ul style="list-style-type: none"> • Solid Green: Asserted when the link is established (Link OK without I/O). • Blinking Green: Asserted when the link is established, and packets are being transmitted along with any receive activity (Access). • Off: No link is detected, or link fails.
2	Speed LED	<ul style="list-style-type: none"> • Solid Blue: Asserted when a 16 Gb link is established and maintained. • Solid Amber: Asserted when an 8 Gb link is established and maintained. • Solid White: Asserted when a 4 Gb and below link is established and maintained. • Off: No link is detected, or link fails.

2.6.4. 2-port 25 GbE iSCSI Host Card (SFP28) LEDs

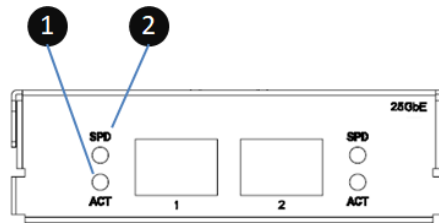

Figure 2-19 2-port 25 GbE iSCSI Host Card (SFP28) LEDs

Table 2-17 Descriptions of the 2-port 25 GbE iSCSI Host Card (SFP28) LEDs

NUMBER	DESCRIPTION	DEFINITION
1	Activity LED	<ul style="list-style-type: none"> Blinking Green: Asserted when the link is established, and packets are being transmitted along with any receive activity (Access). Off: No link is detected, or link fails.
2	Speed LED	<ul style="list-style-type: none"> Solid Blue: Asserted when a 25 Gb link is established and maintained. Solid Amber: Asserted when not a 25 Gb link is established and maintained. Off: No link is detected, or link fails.

2.6.5. 4-port 10 GbE iSCSI Host Card (SFP+) LEDs

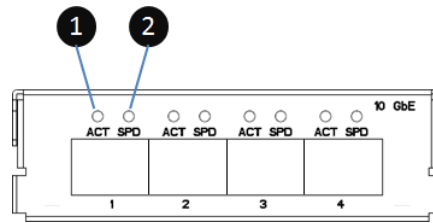

Figure 2-20 4-port 10 GbE iSCSI Host Card (SFP+) LEDs

Table 2-18 Descriptions of the 4-port 10 GbE iSCSI Host Card (SFP+) LEDs

NUMBER	DESCRIPTION	DEFINITION
1	Activity LED	<ul style="list-style-type: none"> Blinking Green: Asserted when the link is established, and packets are being transmitted along with any receive activity (Access). Off: No link is detected, or link fails.
2	Speed LED	<ul style="list-style-type: none"> Solid Blue: Asserted when a 10 Gb link is established and maintained. Solid Amber: Asserted when a 1 Gb link is established and maintained. Off: No link is detected, or link fails.

2.6.6. 2-port 10 GBASE-T iSCSI Host Card (RJ45) LEDs

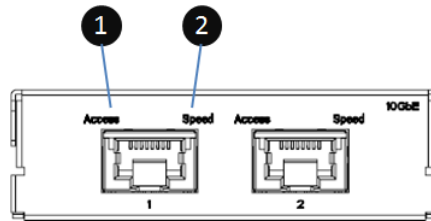

Figure 2-21 2-port 10 GBASE-T iSCSI Host Card (RJ45) LEDs

Table 2-19 Descriptions of the 2-port 10 GBASE-T iSCSI Host Card (RJ45) LEDs

NUMBER	DESCRIPTION	DEFINITION
1	Activity LED	<ul style="list-style-type: none"> Blinking Green: Asserted when the link is established, and packets are being transmitted along with any receive activity (Access). Off: No link is detected, or link fails.
2	Speed LED	<ul style="list-style-type: none"> Solid Green: Asserted when a 10 Gb link is established and maintained. Solid Amber: Asserted when a 1 Gb link is established and maintained. Off: No link is detected, or link fails.

3. INSTALL SYSTEM HARDWARE

This chapter will guide you through the installation process.

3.1. Basic System Installation

For basic system installation, please refer to the [Quick Installation Guide](#) which can be downloaded from the website. You can learn to install the disk drives, optional host cards, rail kits, and power on the storage system to discover and setup the system.

For more information about discovering your system and the initial configuration, please refer to the [QSM Software Manual](#).

3.2. Connecting a UPS (Option)

If you want to install a UPS (uninterruptible power supply) to provide clean power and offer protection against mains power failures, please follow the following instructions.

1. Before you purchase a UPS system, please check the supported UPS interfaces and communication types.
2. Supported types include network UPS via SNMP, serial UPS with COM port, and USB UPS.
3. Connect the UPS to the system via Service Port (UPS).

3.3. Connecting the USB LCM (Option)

If you purchased the USB LCM, please use the enclosed USB extension cable (A-male to A-female) to connect to the system. The following procedures are for the USB LCM connection:

1. Connect the USB LCM to the female side of the USB extension cable.
2. Connect the male side of the USB extension cable to the USB port on the system front pillar.

3.4. Wake-on-LAN / Wake-on-SAS (Option)

You can power on the system remotely using the Wake-on-LAN feature. It can work with any available Wake-on-LAN freeware and shareware.

QSAN's Wake-on-SAS technology allows you to remotely turn on or off all cascaded XD8100 expansion enclosures using QSAN's proprietary SAS cable. Wake-on-SAS ensures that after the head system is shut down for maintenance or other purposes, the expansion enclosure will not run idle, thus consuming power. Wake-on-SAS allows your devices to be turned on only when necessary, thereby avoiding unnecessary waste of electricity. Another advantage of Wake-on-SAS is that when you turn on the head system, the expansion enclosures will automatically wake up, so if you forget to turn them on first, you don't need to worry about degrading the volumes on the expansion enclosures.

3.5. Installing Memory Modules (Option)

If you purchase additional optional memory module for your storage system, please refer to the following image and table for the suggested sequence of memory module installation. It is requested that the installation slot and capacity of the memory module MUST be the same for both controllers.

There are four DIMM slots for expansion of memory capacity. The installation sequence for the memory module should be: #3 -> #2 -> #1 -> #4 due to slot #3 and #4 are the same memory bank. Using different memory banks will improve system performance.

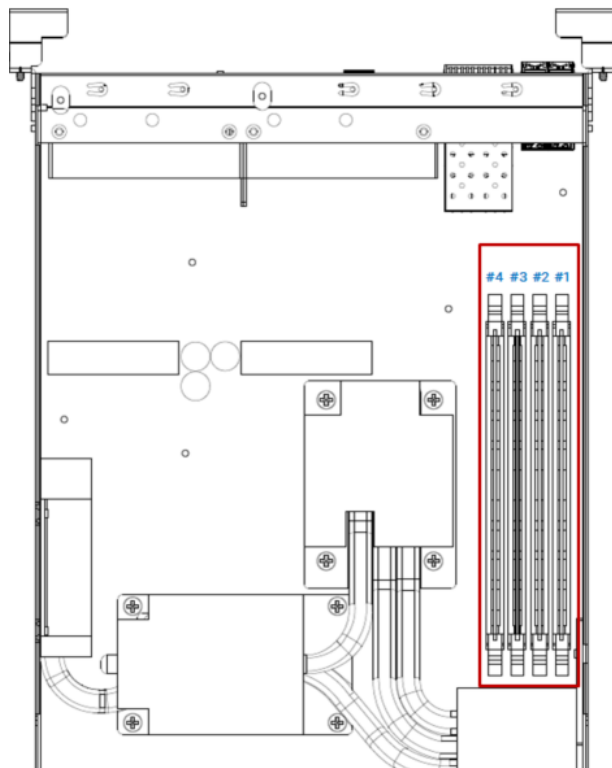

Figure 3-1 Memory Module Slot Number

The following table is the suggested installation sequence for optional memory module.

Table 3-1 Optional Memory Module Installation Sequence

Slot #1	Slot #2	Slot #3	Slot #4	TOTAL MEMORY
-	-	16 GB	-	16 GB
-	16 GB	16 GB	-	32 GB
8 GB	16 GB	16 GB	8 GB	48 GB
16 GB	16 GB	16 GB	16 GB	64 GB
-	32 GB	32 GB	-	64 GB
32 GB	32 GB	32 GB	32 GB	128 GB

64 GB

64 GB

64 GB

64 GB

256 GB



CAUTION

To ensure system stability, you **MUST** install genuine QSAN memory modules to expand the system memory size. The platform does not support mixed installation of DIMMs, so mixed installation of memory combinations is not allowed.



TIP

Insert two DIMMs or more will boost performance.

4. SUPPORT AND OTHER RESOURCES

4.1. Getting Technical Support

After installing your device, locate the serial number on the sticker located on the side of the chassis or from the **QSM -> System -> Maintenance > System Information** and use it to register your product at https://www.qsan.com/business_partnership. We recommend registering your product in QSAN partner website for firmware updates, document download, and latest news in eDM. To contact QSAN Support, please use the following information.

- Via the Web: https://www.qsan.com/technical_support
- Via Telephone: +886-2-77206355
- (Service hours: 09:30 - 18:00, Monday - Friday, UTC+8)
- Via Skype Chat, Skype ID: qsan.support
- (Service hours: 09:30 - 02:00, Monday - Friday, UTC+8, Summer time: 09:30 - 01:00)
- Via Email: support@qsan.com

Information to Collect

- Product name, model or version, and serial number
- Operating system name and version
- Firmware version
- Error messages or capture screenshots
- Product-specific reports and logs
- Add-on products or components installed
- Third-party products or components installed

Information for Technical Support

If the technical support requests you to download the Service Package, please navigate in the **QSM -> System -> Maintenance > System Information**, and then click the **Download Service**

Package button to download. Then the system will automatically generate a zip file the default download location of your web browser.

4.2. Documentation Feedback

QSAN is committed to providing documentation that meets and exceeds your expectations. To help us improve the documentation, email any errors, suggestions, or comments to docsfeedback@qsan.com.

When submitting your feedback, include the document title, part number, revision, and publication date located on the front cover of the document.

APPENDIX

End-User License Agreement (EULA)

Please read this document carefully before you use our product or open the package containing our product.

YOU AGREE TO ACCEPT TERMS OF THIS EULA BY USING OUR PRODUCT, OPENING THE PACKAGE CONTAINING OUR PRODUCT OR INSTALLING THE SOFTWARE INTO OUR PRODUCT. IF YOU DO NOT AGREE TO TERMS OF THIS EULA, YOU MAY RETURN THE PRODUCT TO THE RESELLER WHERE YOU PURCHASED IT FOR A REFUND IN ACCORDANCE WITH THE RESELLER'S APPLICABLE RETURN POLICY.

General

QSAN Technology, Inc. ("QSAN") is willing to grant you ("User") a license of software, firmware and / or other product sold, manufactured or offered by QSAN ("the Product") pursuant to this EULA.

License Grant

QSAN grants to User a personal, non-exclusive, non-transferable, non-distributable, non-assignable, non-sub-licensable license to install and use the Product pursuant to the terms of this EULA. Any right beyond this EULA will not be granted.

Intellectual Property Right

Intellectual property rights relative to the Product are the property of QSAN or its licensor(s). User will not acquire any intellectual property by this EULA.

License Limitations

User may not authorize or permit any third party to: (a) use the Product for any purpose other than in connection with the Product or in a manner inconsistent with the design or documentations of the Product; (b) license, distribute, lease, rent, lend, transfer, assign or otherwise dispose of the Product or use the Product in any commercial hosted or service

bureau environment; (c) reverse engineer, decompile, disassemble or attempt to discover the source code for or any trade secrets related to the Product, except and only to the extent that such activity is expressly permitted by applicable law notwithstanding this limitation; (d) adapt, modify, alter, translate or create any derivative works of the Licensed Software; (e) remove, alter or obscure any copyright notice or other proprietary rights notice on the Product; or (f) circumvent or attempt to circumvent any methods employed by QSAN to control access to the components, features or functions of the Product.

Disclaimer

QSAN DISCLAIMS ALL WARRANTIES OF PRODUCT, INCLUDING BUT NOT LIMITED TO ANY MERCHANTABILITY, FITNESS FOR A PARTICULAR PURPOSE, WORKMANLIKE EFFORT, TITLE, AND NON-INFRINGEMENT. ALL PRODUCTS ARE PROVIDED "AS IS" WITHOUT WARRANTY OF ANY KIND. QSAN MAKES NO WARRANTY THAT THE PRODUCT WILL BE FREE OF BUGS, ERRORS, VIRUSES OR OTHER DEFECTS.

IN NO EVENT WILL QSAN BE LIABLE FOR THE COST OF COVER OR FOR ANY DIRECT, INDIRECT, SPECIAL, PUNITIVE, INCIDENTAL, CONSEQUENTIAL OR SIMILAR DAMAGES OR LIABILITIES WHATSOEVER (INCLUDING, BUT NOT LIMITED TO LOSS OF DATA, INFORMATION, REVENUE, PROFIT OR BUSINESS) ARISING OUT OF OR RELATING TO THE USE OR INABILITY TO USE THE PRODUCT OR OTHERWISE UNDER OR IN CONNECTION WITH THIS EULA OR THE PRODUCT, WHETHER BASED ON CONTRACT, TORT (INCLUDING NEGLIGENCE), STRICT LIABILITY OR OTHER THEORY EVEN IF QSAN HAS BEEN ADVISED OF THE POSSIBILITY OF SUCH DAMAGES.

Limitation of Liability

IN ANY CASE, QSAN'S LIABILITY ARISING OUT OF OR IN CONNECTION WITH THIS EULA OR THE PRODUCT WILL BE LIMITED TO THE TOTAL AMOUNT ACTUALLY AND ORIGINALLY PAID BY CUSTOMER FOR THE PRODUCT. The foregoing Disclaimer and Limitation of Liability will apply to the maximum extent permitted by applicable law. Some jurisdictions do not allow the exclusion or limitation of incidental or consequential damages, so the exclusions and limitations set forth above may not apply.

Termination

If User breaches any of its obligations under this EULA, QSAN may terminate this EULA and take remedies available to QSAN immediately.

Miscellaneous

- QSAN reserves the right to modify this EULA.
- QSAN reserves the right to renew the software or firmware anytime.
- QSAN may assign its rights and obligations under this EULA to any third party without condition.
- This EULA will be binding upon and will inure to User's successors and permitted assigns.
- This EULA shall be governed by and constructed according to the laws of R.O.C. Any disputes arising from or in connection with this EULA, User agree to submit to the jurisdiction of Taiwan Shilin district court as first instance trial.